



CH 06 - PERFORMANCE WITH 4-POLE MOTORS 1400 REVS. INPUT

TYPE	i=ratio	n2 r/min	Kw=P1	Nm=T2	f.s.	Possible types of motor connections	
CH 06	7	200	1.85	75	1.5	90/80	B5/B14
	10	140	1.85	105	1.3	90/80	B5/B14
	12	117	1.85	129	1.1	90/80	B5/B14
	15	93	1.85	146	1.0	90/80	B5/B14
	19	74	1.50	150	1.0	90/80	B5/B14
	24	58	1.10	138	1.1	90/80	B5/B14
	30	47	1.10	155	1.0	90/80	B5/B14
	38	37	0.75	133	1.1	90/80	B5/B14
	45	31	0.75	152	0.9	80/71	B5/B14
	64	22	0.37	101	1.2	80/71	B5/B14
	80	17	0.37	112	1.0	71	B5/B14
	100	14	0.37	110	1.0	71	B5/B14

Weight Kg 5,2

DIMENSIONS

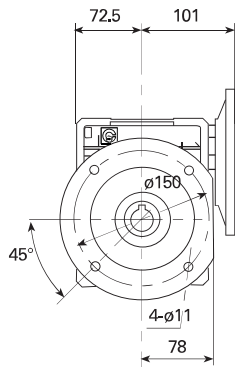
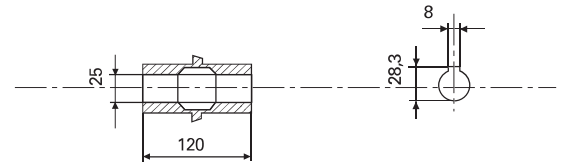
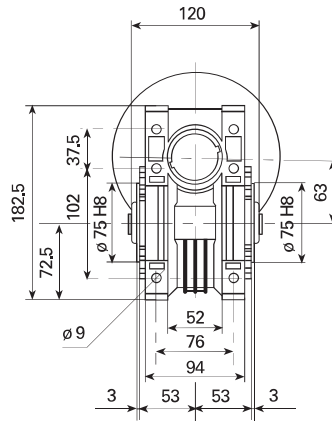
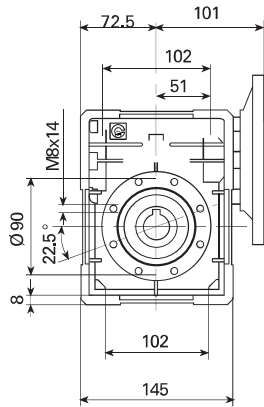

CH06FC 1

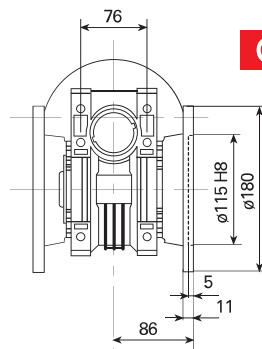

CH06FC 2

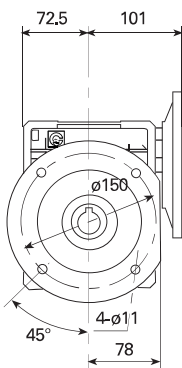

CH06F1

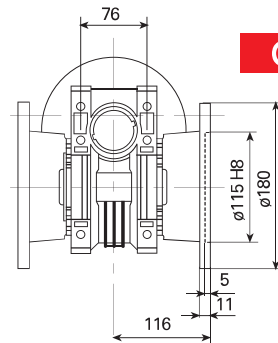

CH06F2