

GN 615-M12-K

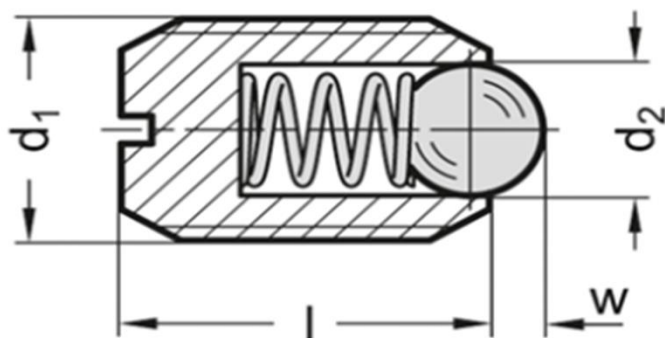

d1	d2	l +0,1	w	Tlak pružiny počáteční	Tlak pružiny koncový
(mm)				(N)	
M12	8	22	2.5	26	49