

GN 615-M5-K

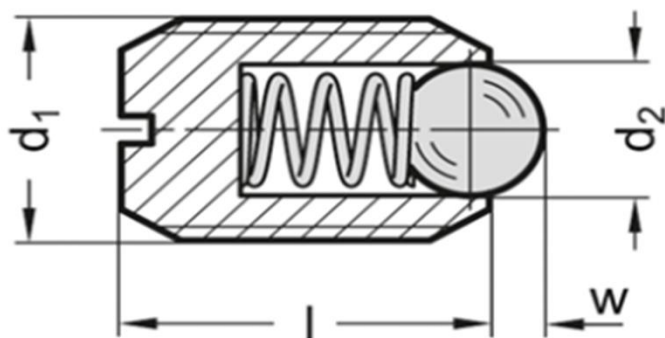

d1	d2	l +0,1	w	Tlak pružiny počáteční	Tlak pružiny koncový
(mm)				(N)	
M5	3	12	0.9	8	16