

MPC 152-8

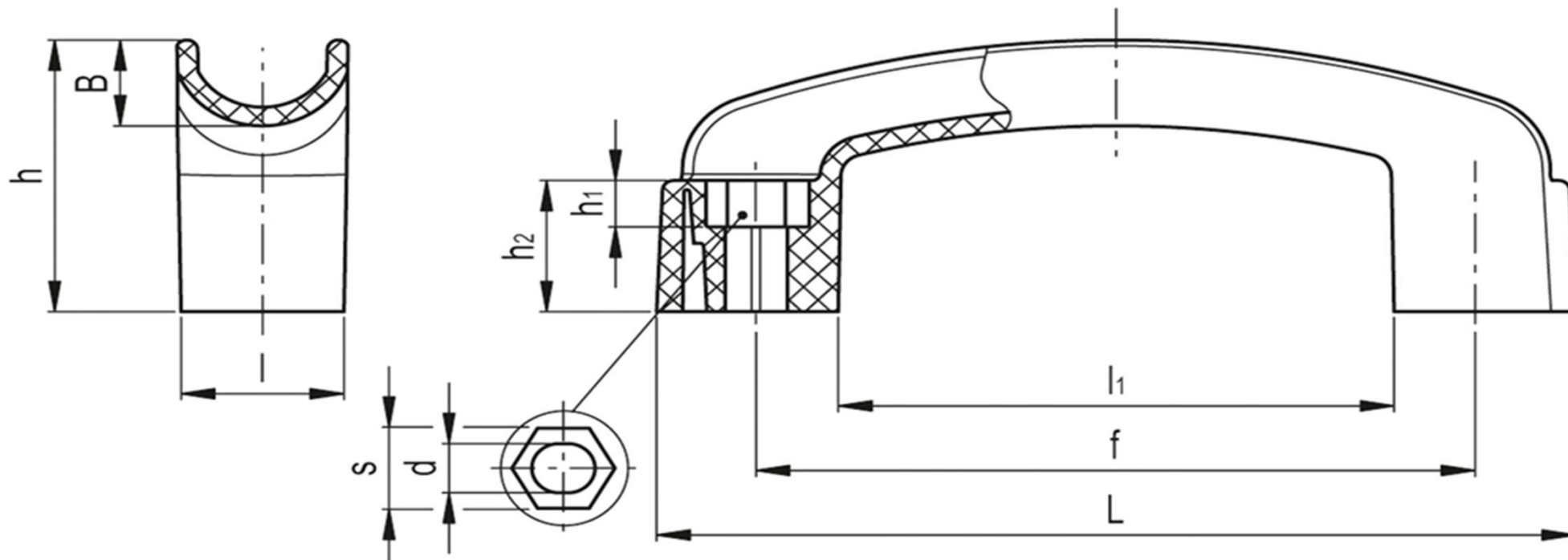

L	l	f±1	d	s	h	h1	h2	B	l1
(mm)									
153	28	117-120	8.5	13	49.5	8.5	24	15.5	93