

# VC.192/25 p-M6x16

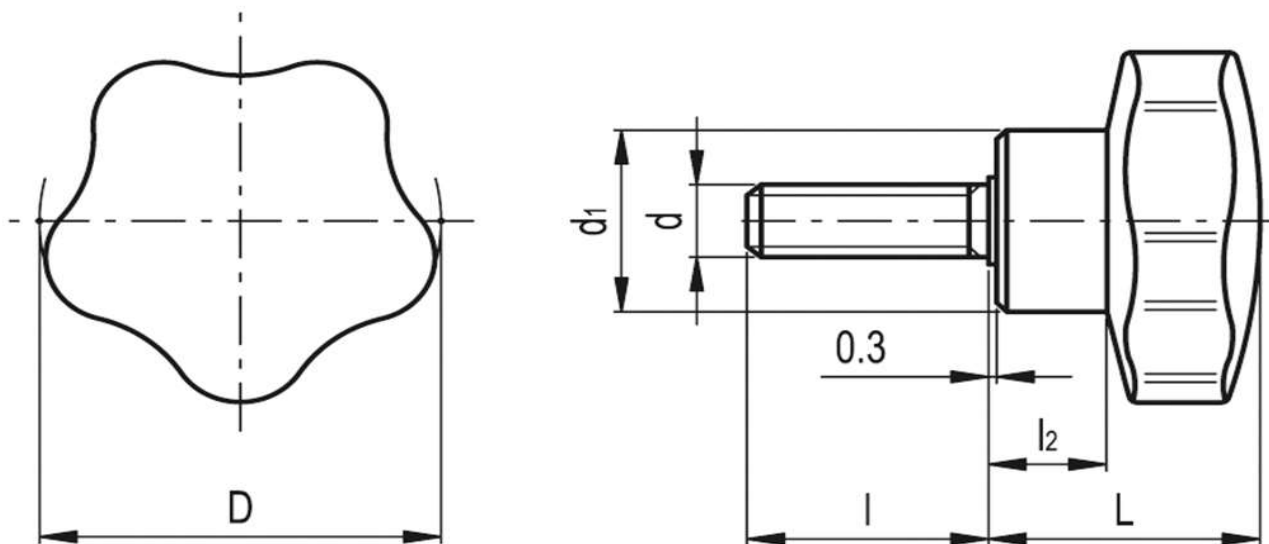

D	d	L	d1	L	d1
(mm)					
25	M6	21	15	16	9