

VC.192/30 p-M8x30

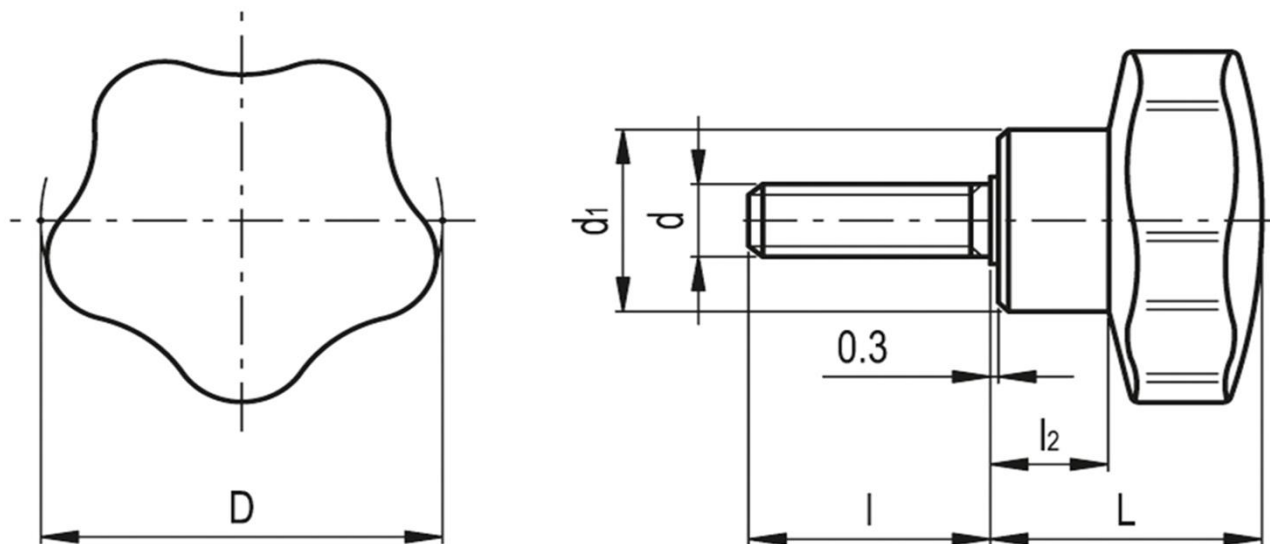

D	d	L	d1	L	d1
(mm)					
32	M8	23	19	30	11