

Řemenice pro klínové řemeny

Profil C

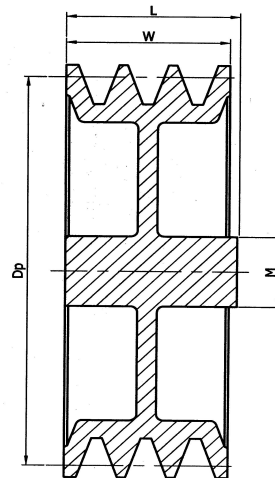

D

C						
Označení řemenice	Roztečný průměr Dp (mm)	Počet drážek	Typ	Průměr náboje M (mm)	Šíře věnce W (mm)	Celková šíře řemenice L (mm)
PT 1 C 140	140	1	D	62	34	58
PT 2 C 140		2	D	70	59,5	58
PT 3 C 140		3	D	74	85	70
PT 4 C 140		4	D	74	110,5	74
PT 5 C 140		5	D	74	136	78
PT 6 C 140		6	D	75	161,5	78
PT 1 C 150	150	1	D	62	34	59
PT 2 C 150		2	D	70	59,5	61
PT 3 C 150		3	D	70	85	70
PT 4 C 150		4	D	74	110,5	74
PT 5 C 150		5	D	75	136	78
PT 6 C 150		6	D	78	161,5	78
PT 1 C 160	160	1	D	62	34	59
PT 2 C 160		2	D	70	59,5	61
PT 3 C 160		3	D	76	85	70
PT 4 C 160		4	D	78	110,5	74
PT 5 C 160		5	D	78	136	78
PT 6 C 160		6	D	82	161,5	78
PT 1 C 170	170	1	D	70	34	60
PT 2 C 170		2	D	70	59,5	62
PT 3 C 170		3	D	76	85	74
PT 4 C 170		4	D	82	110,5	76
PT 5 C 170		5	D	82	136	78
PT 6 C 170		6	D	87	161,5	80
PT 1 C 180	180	1	D	70	34	60
PT 2 C 180		2	D	70	59,5	60
PT 3 C 180		3	D	78	85	72
PT 4 C 180		4	D	82	110,5	74
PT 5 C 180		5	D	82	136	80
PT 6 C 180		6	D	87	161,5	72
PT 1 C 190	190	1	D	70	34	60
PT 2 C 190		2	D	74	59,5	60
PT 3 C 190		3	D	78	85	72
PT 4 C 190		4	D	82	110,5	74
PT 5 C 190		5	D	84	136	80
PT 6 C 190		6	D	88	161,5	85

Příklad označení - vzor objednávky: Řemenice klínová **PT 1 SPC 170**

Řemenice pro klínové řemeny

Profil C

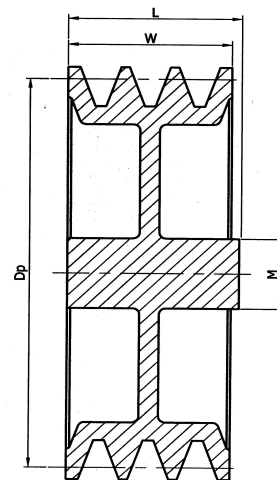

D

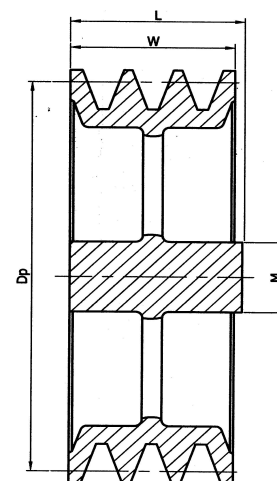

R

C						
Označení řemenice	Roztečný průměr Dp (mm)	Počet drážek	Typ	Průměr náboje M (mm)	Šíře věnce W (mm)	Celková šíře řemenice L (mm)
PT 1 C 200	200	1	D	71	34	60
PT 2 C 200		2	D	73	59,5	72
PT 3 C 200		3	D	83	85	76
PT 4 C 200		4	D	90	110,5	88
PT 5 C 200		5	D	92	136	92
PT 6 C 200		6	D	96	161,5	98
PT 1 C 224	224	1	D	71	34	63
PT 2 C 224		2	D	76	59,5	68
PT 3 C 224		3	D	83	85	76
PT 4 C 224		4	D	93	110,5	90
PT 5 C 224		5	D	93	136	92
PT 6 C 224		6	D	98	161,5	98
PT 1 C 250	250	1	D	82	34	63
PT 2 C 250		2	D	82	59,5	71
PT 3 C 250		3	D	90	85	80
PT 4 C 250		4	D	95	110,5	90
PT 5 C 250		5	D	100	136	96
PT 6 C 250		6	D	102	161,5	102
PT 1 C 280	280	1	D	82	34	64
PT 2 C 280		2	D	82	59,5	74
PT 3 C 280		3	D	90	85	80
PT 4 C 280		4	D	95	110,5	90
PT 5 C 280		5	D	100	136	96
PT 6 C 280		6	R	102	161,5	102
PT 1 C 300	300	1	R	85	34	65
PT 2 C 300		2	R	90	59,5	75
PT 3 C 300		3	R	90	85	80
PT 4 C 300		4	R	105	110,5	90
PT 5 C 300		5	R	105	136	95
PT 6 C 300		6	R	105	161,5	107
PT 1 C 315	315	1	R	85	34	65
PT 2 C 315		2	R	90	59,5	75
PT 3 C 315		3	R	90	85	80
PT 4 C 315		4	R	105	110,5	90
PT 5 C 315		5	R	105	136	95
PT 6 C 315		6	R	105	161,5	107

Příklad označení - vzor objednávky: Řemenice klínová **PT 3 SPC 315**

Řemenice pro klínové řemeny

Profil C

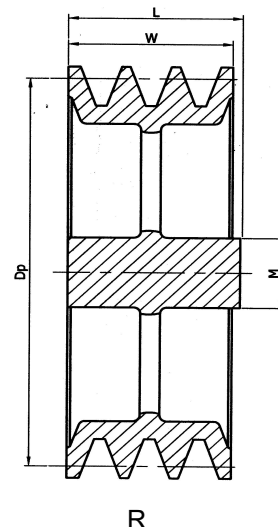

C						
Označení řemenice	Roztečný průměr Dp (mm)	Počet drážek	Typ	Průměr náboje M (mm)	Šíře věnce W (mm)	Celková šíře řemenice L (mm)
PT 1 C 355	355	1	R	100	34	70
PT 2 C 355		2	R	105	59,5	75
PT 3 C 355		3	R	105	85	80
PT 4 C 355		4	R	115	110,5	90
PT 5 C 355		5	R	115	136	95
PT 6 C 355		6	R	115	161,5	110
PT 1 C 400	400	1	R	100	34	70
PT 2 C 400		2	R	105	59,5	75
PT 3 C 400		3	R	105	85	80
PT 4 C 400		4	R	120	110,5	90
PT 5 C 400		5	R	120	136	95
PT 6 C 400		6	R	120	161,5	110
PT 1 C 450	450	1	R	105	34	70
PT 2 C 450		2	R	110	59,5	75
PT 3 C 450		3	R	110	85	80
PT 4 C 450		4	R	120	110,5	95
PT 5 C 450		5	R	120	136	100
PT 6 C 450		6	R	120	161,5	110
PT 1 C 500	500	1	R	110	34	75
PT 2 C 500		2	R	115	59,5	80
PT 3 C 500		3	R	115	85	85
PT 4 C 500		4	R	120	110,5	100
PT 5 C 500		5	R	125	136	110
PT 6 C 500		6	R	125	161,5	115
PT 1 C 560	560	1	R	110	34	75
PT 2 C 560		2	R	115	59,5	80
PT 3 C 560		3	R	115	85	85
PT 4 C 560		4	R	125	110,5	100
PT 5 C 560		5	R	125	136	110
PT 6 C 560		6	R	125	161,5	115
PT 1 C 630	630	1	R	115	34	75
PT 2 C 630		2	R	120	59,5	80
PT 3 C 630		3	R	120	85	95
PT 4 C 630		4	R	130	110,5	100
PT 5 C 630		5	R	130	136	110
PT 6 C 630		6	R	130	161,5	115

Příklad označení - vzor objednávky: Řemenice klínová **PT 5 SPC 500**

Řemenice pro klínové řemeny

Profil SPC - C

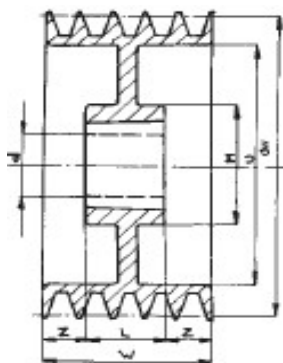

6

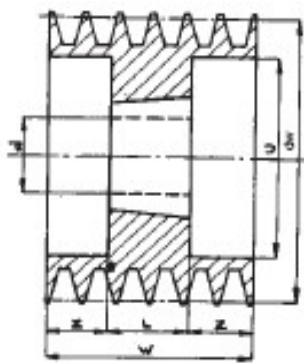

11

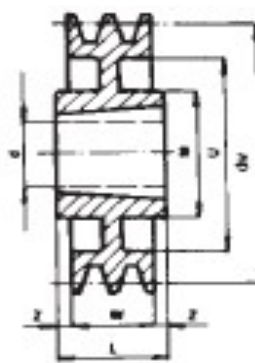

14

SPC - C

Označení řemenice	Roztečný průměr dw (mm)	Počet drážek	Typ	Pouzdro Taper Lock	Šířka věnce W (mm)	Vnitřní průměr věnce U (mm)	Šířka náboje L (mm)	Průměr náboje M (mm)
PBT 3 SPC 224	224	3	11	3020	85	166	51	-
PBT 4 SPC 224		4	11	3020	110,5	166	51	-
PBT 5 SPC 224		5	11	3535	136	166	91	-
PBT 6 SPC 224		6	11	3535	161,5	166	91	-
PBT 8 SPC 224		8	11	3535	212,5	166	91	-
PBT 3 SPC 236	236	3	11	3020	85	178	51	-
PBT 4 SPC 236		4	11	3535	110,5	178	91	-
PBT 5 SPC 236		5	11	3535	136	178	91	-
PBT 6 SPC 236		6	11	3535	161,5	178	91	-
PBT 8 SPC 236		8	11	3535	212,5	178	91	-
PBT 3 SPC 250	250	3	6	3020	85	192	51	146
PBT 4 SPC 250		4	11	3535	110,5	192	91	-
PBT 5 SPC 250		5	11	3535	136	192	91	-
PBT 6 SPC 250		6	11	3535	161,5	192	91	-
PBT 8 SPC 250		8	11	3535	212,5	192	91	-
PBT 3 SPC 265	265	3	6	3020	85	207	51	146
PBT 4 SPC 265		4	6	3535	110,5	207	91	178
PBT 5 SPC 265		5	6	3535	136	207	91	178
PBT 6 SPC 265		6	6	3535	161,5	207	91	178
PBT 8 SPC 265		8	6	3535	212,5	207	91	178
PBT 3 SPC 280	280	3	6	3020	85	222	51	146
PBT 4 SPC 280		4	6	3535	110,5	222	91	178
PBT 5 SPC 280		5	6	3535	136	222	91	178
PBT 6 SPC 280		6	6	3535	161,5	222	91	178
PBT 8 SPC 280		8	11	4040	212,5	222	101	-
PBT 3 SPC 300	300	3	14	3535	85	242	91	178
PBT 4 SPC 300		4	6	3535	110,5	242	91	178
PBT 5 SPC 300		5	6	3535	136	242	91	178
PBT 6 SPC 300		6	6	3535	161,5	242	91	178
PBT 8 SPC 300		8	6	4040	212,5	242	101	215
PBT 3 SPC 315	315	3	14	3535	85	257	91	178
PBT 4 SPC 315		4	6	3535	110,5	257	91	178
PBT 5 SPC 315		5	6	3535	136	257	91	178
PBT 6 SPC 315		6	6	4040	161,5	257	101	215
PBT 8 SPC 315		8	6	4040	212,5	257	101	215

Příklad označení - vzor objednávky: Řemenice klínová **PBT 4 SPC 300 - 3535 TL**

Řemenice pro klínové řemeny

Profil SPC - C

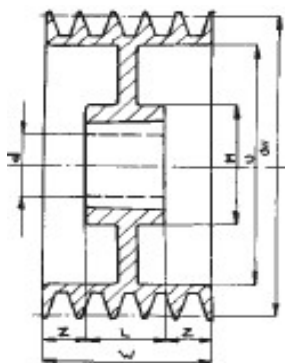

6

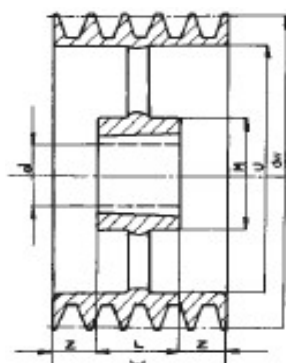

9

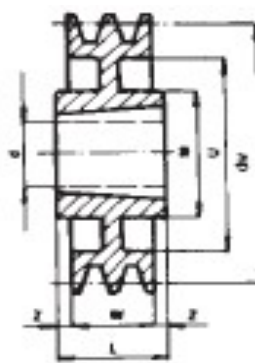

14

SPC - C

Označení řemenice	Roztečný průměr dw (mm)	Počet drážek	Typ	Pouzdro Taper Lock	Šířka věnce W (mm)	Vnitřní průměr věnce U (mm)	Šířka náboje L (mm)	Průměr náboje M (mm)
PBT 3 SPC 335	335	3	14	3535	85	277	91	178
PBT 4 SPC 335		4	6	3535	110,5	277	91	178
PBT 5 SPC 335		5	6	3535	136	277	91	178
PBT 6 SPC 335		6	6	4040	161,5	277	101	215
PBT 8 SPC 335		8	6	4040	212,5	277	101	215
PBT 3 SPC 355	355	3	14	3535	85	297	91	178
PBT 4 SPC 355		4	6	3535	110,5	297	91	178
PBT 5 SPC 355		5	6	4040	136	297	101	215
PBT 6 SPC 355		6	6	4040	161,5	297	101	215
PBT 8 SPC 355		8	6	4040	212,5	297	101	215
PBT 3 SPC 400	400	3	3	3535	85	342	91	178
PBT 4 SPC 400		4	9	3535	110,5	342	91	178
PBT 5 SPC 400		5	9	4040	136	342	101	215
PBT 6 SPC 400		6	9	4040	161,5	342	101	215
PBT 8 SPC 400		8	6	5050	212,5	342	126	267
PBT 3 SPC 450	450	3	3	3535	85	392	91	178
PBT 4 SPC 450		4	9	3535	110,5	392	91	178
PBT 5 SPC 450		5	9	4040	136	392	101	215
PBT 6 SPC 450		6	9	4040	161,5	392	101	215
PBT 8 SPC 450		8	6	5050	212,5	392	126	267
PBT 3 SPC 500	500	3	3	3535	85	442	91	178
PBT 4 SPC 500		4	9	4040	110,5	442	101	215
PBT 5 SPC 500		5	9	4040	136	442	101	215
PBT 6 SPC 500		6	9	4040	161,5	442	101	215
PBT 8 SPC 500		8	9	5050	212,5	442	126	267
PBT 3 SPC 560	560	3	3	3535	85	502	91	178
PBT 4 SPC 560		4	9	4040	110,5	502	101	215
PBT 5 SPC 560		5	9	4040	136	502	101	215
PBT 6 SPC 560		6	9	5050	161,5	502	126	267
PBT 8 SPC 560		8	9	5050	212,5	502	126	267
PBT 3 SPC 630	630	3	3	4040	85	572	101	215
PBT 4 SPC 630		4	9	4040	110,5	572	101	215
PBT 5 SPC 630		5	9	5050	136	572	126	267
PBT 6 SPC 630		6	9	5050	161,5	572	126	267
PBT 8 SPC 630		8	9	5050	212,5	572	126	267

Příklad označení - vzor objednávky: Řemenice klínová **PBT 4 SPC 300 - 3535 TL**

Řemenice pro klínové řemeny

Profil SPC - C

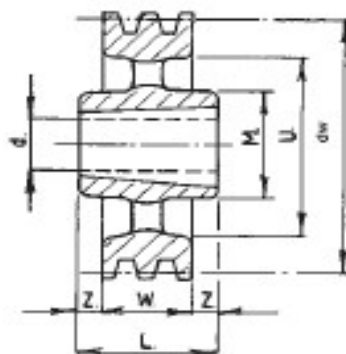
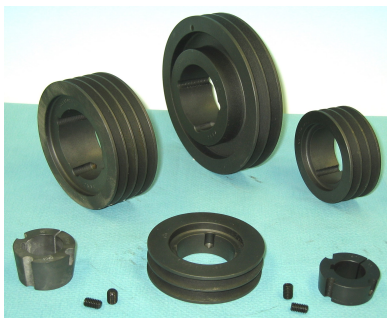

3

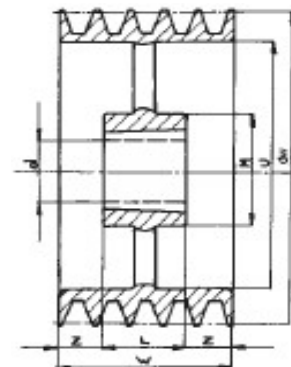

9

SPC - C

Označení řemenice	Roztečný průměr dw (mm)	Počet drážek	Typ	Pouzdro Taper Lock	Šířka věnce W (mm)	Vnitřní průměr věnce U (mm)	Šířka náboje L (mm)	Průměr náboje M (mm)
PBT 3 SPC 710	710	3	3	4040	85	652	101	215
PBT 4 SPC 710		4	9	4040	110,5	652	101	215
PBT 5 SPC 710		5	9	5050	136	652	126	267
PBT 6 SPC 710		6	9	5050	161,5	652	126	267
PBT 8 SPC 710		8	9	5050	212,5	652	126	267
PBT 3 SPC 800	800	3	3	4040	85	742	101	215
PBT 4 SPC 800		4	3	5050	110,5	742	126	267
PBT 5 SPC 800		5	9	5050	136	742	126	267
PBT 6 SPC 800		6	9	5050	161,5	742	126	267
PBT 8 SPC 800		8	9	5050	212,5	742	126	267
PBT 3 SPC 1000	1000	3	3	4040	85	942	101	215
PBT 4 SPC 1000		4	3	5050	110,5	942	126	267
PBT 5 SPC 1000		5	9	5050	136	942	126	267
PBT 6 SPC 1000		6	9	5050	161,5	942	126	267
PBT 8 SPC 1000		8	9	5050	212,5	942	126	267
PBT 3 SPC 1250	1250	3	3	5050	85	1190	126	267
PBT 4 SPC 1250		4	3	5050	110,5	1190	126	267
PBT 5 SPC 1250		5	9	5050	136	1190	126	267
PBT 6 SPC 1250		6	9	5050	161,5	1190	126	267
PBT 8 SPC 1250		8	9	5050	212,5	1190	126	267

Příklad označení - vzor objednávky: Řemenice klínová **PBT 6 SPC 1000 - 5050 TL**