

Válečkové řetězy

Jednořadé

Evropská (BS) norma - DIN 8187

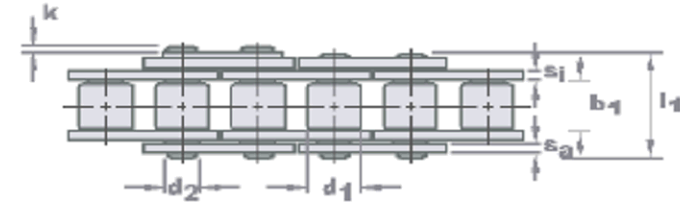
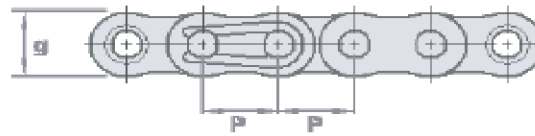

26



30



58



59

Jednořadé válečkové řetězy - Evropská řada

Označení řetězu podle DIN / ISO	Obchodní označení řetězu p x b ₁ (")	Rozteč řetězu p (mm)	Vnitř. šířka vnitř. článku b _{1min} (mm)	Průměr válečku d _{1max} (mm)	Výška destičky g _{max} (mm)	Tloušťka vnitřní destičky s _i (mm)	Tloušťka vnější destičky s _a (mm)	Průměr čepu d _{2max} (mm)	Délka čepu l _{1max} (mm)	Vzdálenost řad řetězu e (mm)	Měrná hmotnost q (kg/m)	Spojovací články			
												26 (E)	30 (C)	58 (S)	59 (L)
03	5 x 2,5 mm	5,00	2,50	3,20	4,10	0,57	0,57	1,49	7,40	-	0,08	●	●	●	-
04	6 x 2,8 mm	6,00	2,80	4,00	5,00	0,57	0,57	1,85	7,40	-	0,12	●	●	-	-
05B-1	8 x 3 mm	8,00	3,00	5,00	7,10	0,73	0,73	2,31	8,60	-	0,18	●	●	●	-
06B-1	3/8" x 7/32"	9,525	5,72	6,35	8,20	1,25	1,00	3,28	13,50	-	0,41	●	●	-	-
081	1/2" x 1/8"	12,70	3,30	7,75	9,90	1,00	1,00	3,66	10,20	-	0,28	●	●	-	-
083	1/2" x 3/16"	12,70	4,88	7,75	9,90	1,00	1,00	3,66	10,70	-	0,32	●	-	-	-
08B-1	1/2" x 5/16"	12,70	7,75	8,51	11,80	1,50	1,50	4,45	17,00	-	0,70	●	●	●	●
10B-1	5/8" x 3/8"	15,875	9,65	10,16	14,70	1,50	1,50	5,08	19,60	-	0,95	●	●	●	●
12B-1	3/4" x 7/16"	19,05	11,68	12,07	16,10	1,76	1,76	5,72	22,70	-	1,25	●	●	●	●
16B-1	1" x 43/64"	25,40	17,02	15,88	21,00	4,00	3,00	8,28	36,10	-	2,70	●	●	●	●
20B-1	1 1/4" x 3/4"	31,75	19,56	19,05	26,40	4,40	3,50	10,19	43,20	-	3,60	●	●	●	●
24B-1	1 1/2" x 1"	38,10	25,40	25,40	33,40	5,90	5,00	14,63	53,40	-	6,70	-	●	●	●
28B-1	1 3/4" x 1 7/32"	44,45	30,99	27,94	37,00	7,62	6,35	15,90	65,10	-	8,60	-	-	●	●
32B-1	2" x 1 7/32"	50,80	30,99	29,21	42,20	7,11	6,35	17,81	67,40	-	10,50	-	-	●	●
40B-1	2 1/2" x 1 1/2"	63,50	38,10	39,37	52,90	8,64	8,10	22,89	82,60	-	16,00	-	-	●	●
48B-1	3" x 1 4/5"	76,20	45,72	48,26	63,80	12,19	10,16	29,24	99,10	-	25,00	-	-	●	-
56B-1	3 1/2" x 2 1/8"	88,90	53,34	53,98	77,80	13,72	12,45	34,32	114,00	-	35,00	-	-	●	-
64B-1	4" x 2 3/8"	101,60	60,96	63,50	90,10	15,24	13,72	39,40	130,00	-	60,00	-	-	●	-

Válečkové řetězy

Dvouřadé

Evropská (BS) norma - DIN 8187

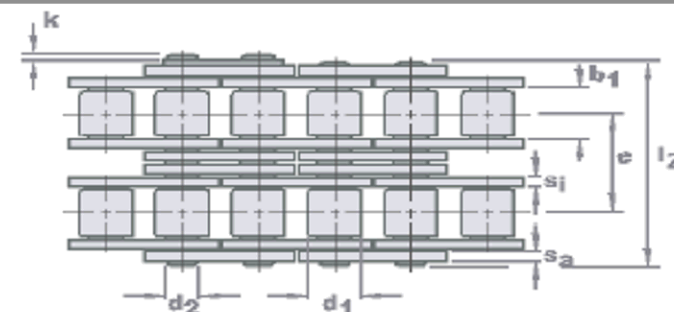
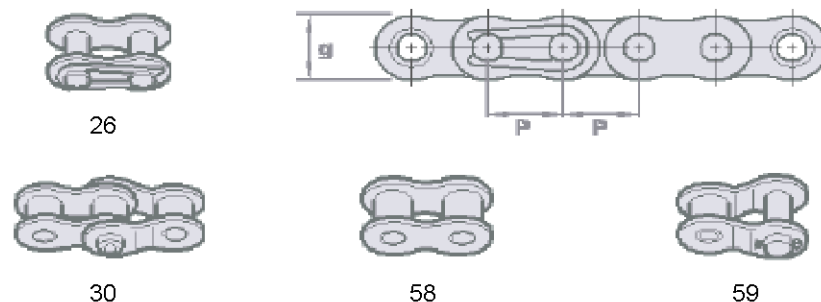

Dvouřadé válečkové řetězy - Evropská řada

Označení řetězu podle DIN / ISO	Obchodní označení řetězu p x b ₁ (")	Rozteč řetězu p (mm)	Vnitř. šířka vnitř. článku b _{1min} (mm)	Průměr válečku d _{1max} (mm)	Výška destičky g _{max} (mm)	Tloušťka vnitřní destičky s _i (mm)	Tloušťka vnější destičky s _a (mm)	Průměr čepu d _{2max} (mm)	Délka čepu l _{1max} (mm)	Vzdálenost řad řetězu e (mm)	Měrná hmotnost q (kg/m)	Spojovací články			
												26 (E)	30 (C)	58 (S)	59 (L)
05B-2	8 x 3 mm	8,00	3,00	5,00	7,10	0,73	0,73	2,31	14,30	5,64	0,36	●	●	●	-
06B-2	3/8" x 7/32"	9,525	5,72	6,35	8,20	1,25	1,00	3,28	23,80	10,24	0,78	●	●	-	-
08B-2	1/2" x 5/16"	12,70	7,75	8,51	11,80	1,50	1,50	4,45	31,00	13,92	1,35	●	●	●	●
10B-2	5/8" x 3/8"	15,875	9,65	10,16	14,70	1,50	1,50	5,08	36,20	16,59	1,85	●	●	●	●
12B-2	3/4" x 7/16"	19,05	11,68	12,07	16,10	1,76	1,76	5,72	42,20	19,46	2,50	●	●	●	●
16B-2	1" x 43/64"	25,40	17,02	15,88	21,00	4,00	3,00	8,28	68,00	31,88	5,40	●	●	●	●
20B-2	1 1/4" x 3/4"	31,75	19,56	19,05	26,40	4,40	3,50	10,19	79,70	36,45	7,20	●	●	●	●
24B-2	1 1/2" x 1"	38,10	25,40	25,40	33,40	5,90	5,00	14,63	101,00	48,36	13,50	-	●	●	●
28B-2	1 3/4" x 1 7/32"	44,45	30,99	27,94	37,00	7,62	6,35	15,90	124,00	59,56	16,60	-	-	●	●
32B-2	2" x 1 7/32"	50,80	30,99	29,21	42,20	7,11	6,35	17,81	126,00	58,55	21,00	-	-	●	●
40B-2	2 1/2" x 1 1/2"	63,50	38,10	39,37	52,90	8,64	8,10	22,89	154,00	72,29	32,00	-	-	●	●
48B-2	3" x 1 4/5"	76,20	45,72	48,26	63,80	12,19	10,16	29,24	190,00	91,21	50,00	-	-	●	-
56B-2	3 1/2" x 2 1/8"	88,90	53,34	53,98	77,80	13,72	12,45	34,32	221,00	106,60	70,00	-	-	●	-
64B-2	4" x 2 3/8"	101,60	60,96	63,50	90,10	15,24	13,72	39,40	250,00	119,89	120,00	-	-	●	-

Válečkové řetězy

Trojřadé

Evropská (BS) norma - DIN 8187

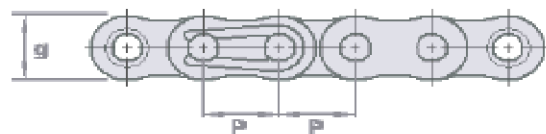
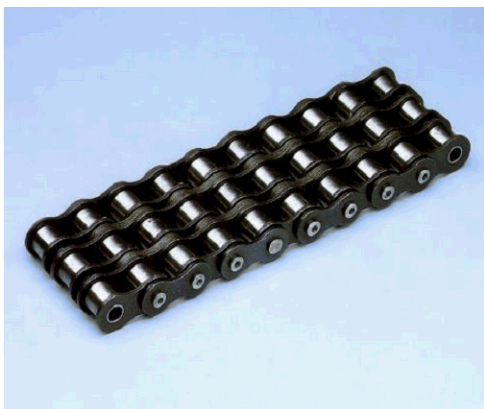

26



58



30



59

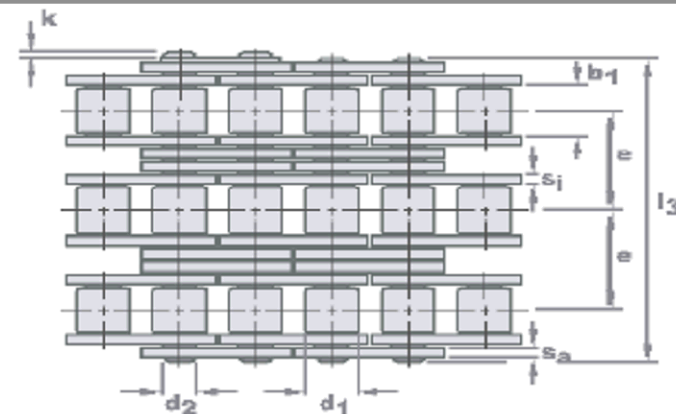

Trojřadé válečkové řetězy - Evropská řada

Označení řetězu podle DIN / ISO	Obchodní označení řetězu p x b ₁ (")	Rozteč řetězu p (mm)	Vnitř. šířka vnitř. článku b _{1min} (mm)	Průměr válečku d _{1max} (mm)	Výška destičky g _{max} (mm)	Tloušťka vnitřní destičky s _i (mm)	Tloušťka vnější destičky s _a (mm)	Průměr čepu d _{2max} (mm)	Délka čepu l _{1max} (mm)	Vzdálenost řad řetězu e (mm)	Měrná hmotnost q (kg/m)	Spojovací články			
												26 (E)	30 (C)	58 (S)	59 (L)
05B-3	8 x 3 mm	8,00	3,00	5,00	7,10	0,73	0,73	2,31	19,90	5,64	0,54	●	●	-	-
06B-3	3/8" x 7/32"	9,525	5,72	6,35	8,20	1,25	1,00	3,28	34,00	10,24	1,18	●	●	-	-
08B-3	1/2" x 5/16"	12,70	7,75	8,51	11,80	1,50	1,50	4,45	44,90	13,92	2,00	●	●	-	-
10B-3	5/8" x 3/8"	15,875	9,65	10,16	14,70	1,50	1,50	5,08	52,80	16,59	2,80	●	●	-	-
12B-3	3/4" x 7/16"	19,05	11,68	12,07	16,10	1,76	1,76	5,72	61,70	19,46	3,80	●	●	-	-
16B-3	1" x 43/64"	25,40	17,02	15,88	21,00	4,00	3,00	8,28	99,90	31,88	8,00	●	●	-	-
20B-3	1 1/4" x 3/4"	31,75	19,56	19,05	26,40	4,40	3,50	10,19	116,00	36,45	11,00	●	●	-	-
24B-3	1 1/2" x 1"	38,10	25,40	25,40	33,40	5,90	5,00	14,63	150,00	48,36	21,00	-	●	●	-
28B-3	1 3/4" x 1 7/32"	44,45	30,99	27,94	37,00	7,62	6,35	15,90	184,00	59,56	25,00	-	-	●	●
32B-3	2" x 1 7/32"	50,80	30,99	29,21	42,20	7,11	6,35	17,81	184,00	58,55	27,95	-	-	●	●
40B-3	2 1/2" x 1 1/2"	63,50	38,10	39,37	52,90	8,64	8,10	22,89	227,00	72,29	48,00	-	-	●	●
48B-3	3" x 1 4/5"	76,20	45,72	48,26	63,80	12,19	10,16	29,24	281,00	91,21	75,00	-	-	●	-